

PRELIMINARY TECHNICAL INFORMATION

**HIGHLIGHTS**

- CBI topology
- Compact design
- Current, voltage and temperature sensors
- IGBT drivers included
- Ready to use

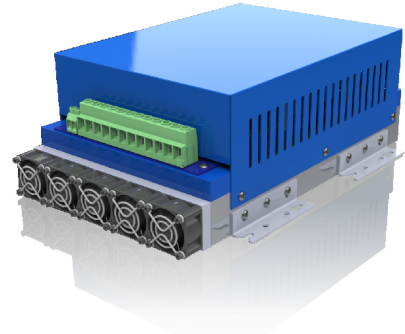

non-contractual photo

**ABOUT MTL SERIES**

RECTIFICADORES GUASCH S.A. offers a compact and ready-to-use Converter-Brake-Inverter power stack for motor control or inverter applications. This power stack includes the IGBTs (CBI module) with a heatsink, the optocoupled drivers, output phase current sensors, DC-Link voltage sensors and module temperature. The customer can work in a short delivery time with a wide range of power assemblies in a compact size.

The MTL series takes the low range of power from our MT Series of IGBTs power stacks. MT series is suitable to realize converters, choppers, half, full or three phase bridge inverters for motor control, welding, renewable energies, UPS, etc.

**BRIEFING**

Topology	B6U+ capacitor bank + brake + B6I (CBI)
Market	industrial
Cooling system	natural convection
Driver system	SCiCoreDrive72
Parameters monitorized	DC-Link voltage, Output current (3 phase) internal module NTC
Max Voltage applied to DCLink	750 V
Output current per phase	$f_{sw}=10\text{ kHz}, T_J < 125^\circ\text{C}, T_{env}=40^\circ\text{C}$ $f_o=50\text{ Hz}, PF=0.85, m=1, V_{IN}=400\text{ V}_{RMS}$

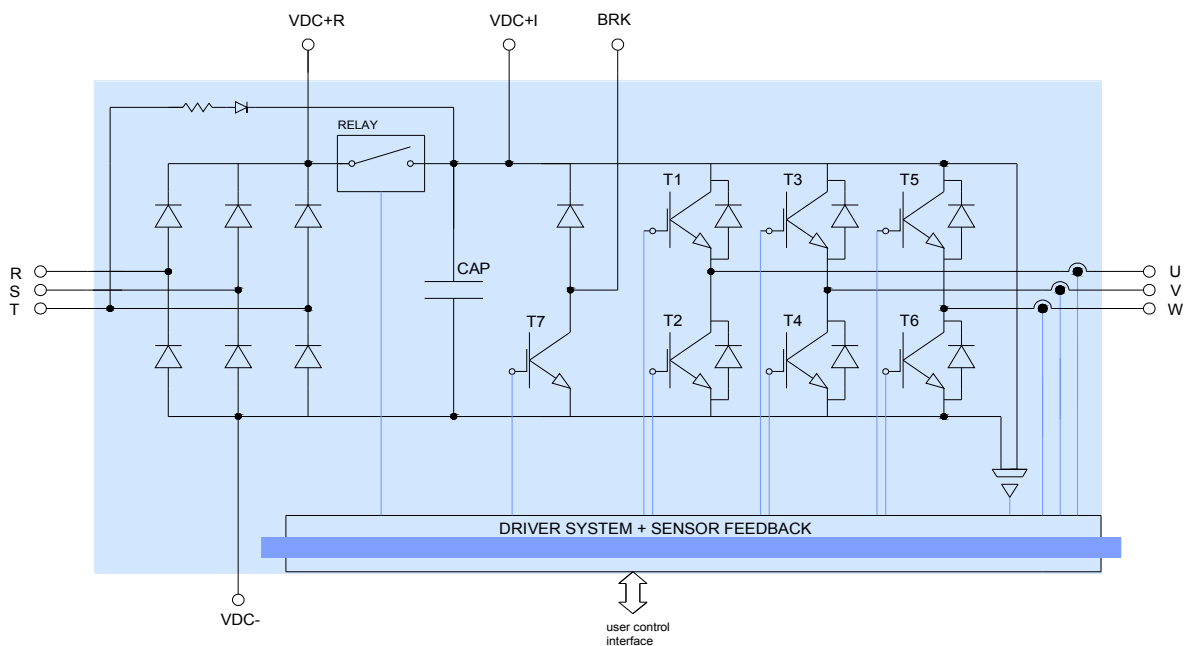

110721 Rev.:4

Reserves the right to change limits, test conditions and dimensions given in this data sheet at any time without previous notice.

### POWER STACK GENERAL CHARACTERISTICS

Description	symbol	notes/test conditions	min.	typ.	max.	units
Input AC voltage	$V_{IN\ RMS}$	network voltage (+15%)		400	460	$V_{RMS}$
Max DC voltage	$V_{DClink}$				750	$V_{DC}$
Output current per phase	$I_{U,V,W}$	$f_{sw}=10\ kHz, T_J<125^\circ C, T_{erriv}=40^\circ C$ $f_o=50\ Hz, PF=0.85, m=1, V_{IN}=400\ V_{RMS}$			10	$A_{RMS}$
IGBT maximum junction temperature	$T_{Jmax}$				150	$^\circ C$
IGBT temp. under switching conditions	$T_{J(sw)}$		-40		125	$^\circ C$
Storage temperature	$T_{stg}$		-40		85	$^\circ C$
Operating temperature	$T_{op}$		-25		85	$^\circ C$
Power-to-control isolation voltage	$V_{ISOpc}$	50 Hz @1 min/ <b>note 1</b>	3			$kV_{AC}$
Module isolation voltage	$V_{ISOmod}$	50 Hz @1 min/ <b>note 2</b>	2.5			$kV$
Weight (aprox)					5.8	kg

### RECTIFIER BRIDGE CHARACTERISTICS

Description	symbol	notes/test conditions	min.	typ.	max.	units
Repetitive reverse voltage	$V_{RRM}$	$T_J=25^\circ C$			1600	V
Average forward current	$I_{FAV}$	$T_C=80^\circ C, T_J=150^\circ C$			37	A
Max DC output rectifier current	$I_{FRMS}$	$T_C=80^\circ C, T_J=150^\circ C$			105	A
Forward voltage	$V_F$	$I_C=37\ A, T_J=125^\circ C$		1.21		V

### CAPACITOR BANK CHARACTERISTICS

Description	symbol	typ.	units
Single capacitor	C	Electrolytic type	1000 $\mu F$ 250 V
Total equivalent capacitance	$C_{equiv}$	1000	$\mu F$
Capacitance Tolerance			$\pm 20\%$
max capacitor bank DC voltage	$V_{DClink}$	750	V

### COOLING SYSTEM CHARACTERISTICS

Description	symbol	notes/test conditions	Typical	Units
Type		natural convection		
Fan system supply voltage	$V_{FAN}$		N/A	$V_{DC}$
Fan system consumption	$I_{FAN}$		N/A	mA

**note 1:** This isolation voltage is referred to the minimum isolation voltage between any control/feedback signal (PWM, reset, fault, feedback sensor signals and supply) and any power voltage (AC/DC input, AC output).

**note 2:** This is an inner property of the IGBT module. It refers to the isolation between the internal chip and the external case.

### BRAKE ARM CHARACTERISTICS

Description	symbol	notes/test conditions	min.	typ.	max.	units
<b>BRAKE IGBT</b>						
Collector-Emitter Voltage	$V_{CES}$	$T_J=25^{\circ}C$			1200	V
DC Collector current	$I_{C80}$	$T_C=80^{\circ}C, T_J=150^{\circ}C$			12	A
Collector-emitter saturation voltage	$V_{CESat}$	$I_C=12 A, T_J=125^{\circ}C$		2.94		V
<b>BRAKE DIODE</b>						
Repetitive reverse voltage	$V_{RRM}$	$T_J=25^{\circ}C$			1200	V
Average forward current	$I_{FAV}$	$T_C=80^{\circ}C, T_J=150^{\circ}C$			8	A
Forward voltage	$V_F$	$I_C=8 A, T_J=125^{\circ}C$		2.51		V

### INVERTER CHARACTERISTICS

Description	symbol	notes/test conditions	min.	typ.	max.	units
<b>INVERTER IGBT</b>						
Collector-Emitter Voltage	$V_{CES}$	$T_J=25^{\circ}C$			1200	V
DC Collector current	$I_{C80}$	$T_C=80^{\circ}C, T_J=150^{\circ}C$			12	A
Collector-emitter saturation voltage	$V_{CESat}$	$I_C=12 A, T_J=125^{\circ}C$		2.94		V
<b>FREE WHEELING DIODE</b>						
Repetitive reverse voltage	$V_{RRM}$	$T_J=25^{\circ}C$			1200	V
Average forward current	$I_{FAV}$	$T_C=80^{\circ}C, T_J=150^{\circ}C$			13	A
Forward voltage	$V_F$	$I_C=13 A, T_J=125^{\circ}C$		2.27		V

### ENVIRONMENTAL SPECIFICATIONS

Description	
Protection grade (EN-60529 / CEI529 / UNE-20324)	IP-00
Humidity max.	50% RH @ 35°C / 90% RH @ 20°C
Pollution degree	III

### MOUNTING CONSIDERATIONS

It's necessary a minimum distance of 100 mm with regard to the envelope. The free air circulation should be guaranteed. Avoiding the heat sources of nearby to assembly.

In the real applications it is important to consider a safety margin with regarding the working current, we recommend a margin of the 20%.

For critical cases (24 hours work, repetitive overloads...), margins of the 30% to 50% are used.

## DRIVERS GENERAL CHARACTERISTICS

MTL includes a 7-channel driver designed to control CBI topology with an internal isolated DC-DC converter per channel.

Includes a  $V_{CE}$  monitoring of each IGBT, providing the necessary protection of this one in case of desat failure by soft turning-off the corresponding IGBT, and triggering an optically isolated feedback fault signal, it also provides an under voltage lock out protection to avoid trigger the IGBT with insufficient gate voltage. Each one of the 7 drivers are completely independent from the others.

Description	symbol	notes/test conditions	min.	typ.	max.	units
Logic low input voltages (PWM & reset)	$V_{IN,RESET}$		-0.5		0.8	V
Logic high input voltages (PWM & reset)	$V_{IN,RESET}$		2.0		5.5	V
Logic high input voltages (relay)	$V_{RELAY}$			5		V
Fault output current	$I_{FAULT}$				8	mA
Logic low input current (PWM & reset)	$I_{IN,RESET}$		-0.5	-0.4		mA
Logic high input current (relay)	$I_{IN,RELAY}$	$V_{RELAY} = 5V$			20	mA
high output propagation time	$t_{d ON}$			300		ns
				440		
low output propagation time	$t_{d OFF}$			320		ns
		$C_G = 10 \text{ nF}$		460		
desat. detection to FAULT output delay	$t_{d FAULT}$	$R_G = 15 \Omega$		1.8	5	$\mu\text{s}$
blanking time	$t_{blank}$	$f_{SW} = 10 \text{ kHz}$			2.8	$\mu\text{s}$
desat. detection to 90% $V_{OUT}$	$t_{d DES(90)}$			0.3	0.5	$\mu\text{s}$
desat. detection to 10% $V_{OUT}$	$t_{d DES(10)}$			2	3	$\mu\text{s}$
reset to fault	$t_{d RES FAULT}$		3	7	20	$\mu\text{s}$
minimum pulse width for RESET	$PW_{RES\_min}$		0.1			$\mu\text{s}$

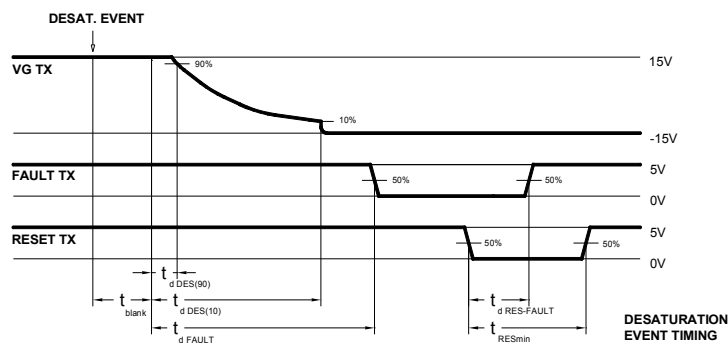
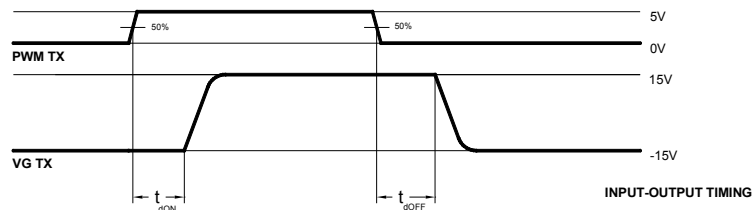

### Warning Note:

Driver system does not generate dead time between channels. The user must ensure a correct dead time generation (no less than  $1 \mu\text{s}$ ) with the control signals between the two IGBTs from each branch. If both IGBTs from a branch switch on at the same time the module can be damaged.

### SENSORS ELECTRICAL CHARACTERISTICS

Description	symbol	notes/test conditions	min	typ.	max.	units
Supply voltage	$V_{CC}$			±15		V
Feedback signal of output current	$V_{CUW}$	Accuracy=±0.65%	-7.5		7.5	V
Output current measurable range		@ $I_{meas}=10\text{ A}$	-10		10	A
Feedback signal of VDC-link voltage	$V_U$	Accuracy=±0.8%	0		7.5	V
DC-link voltage measurable range		@ $V_{DC}=750\text{V}$	0		750	$V_{DC}$
NTC rated resistance	$R_{NTC\ 25}$	internal module NTC $T_c=25^\circ\text{C}$		5		k $\Omega$
NTC B value	$B_{25/50}$	<b>note 3</b>		3375		K

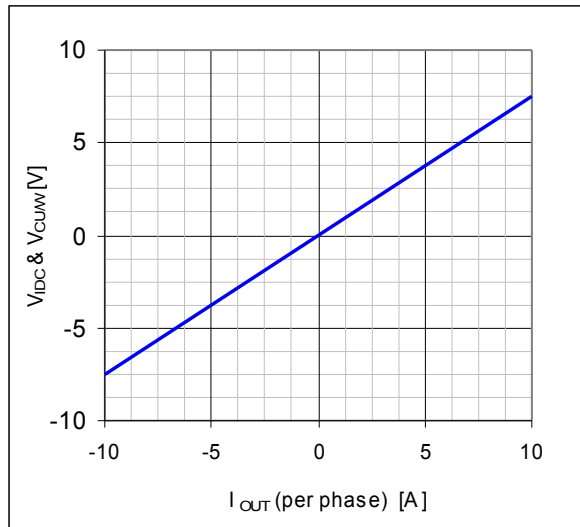
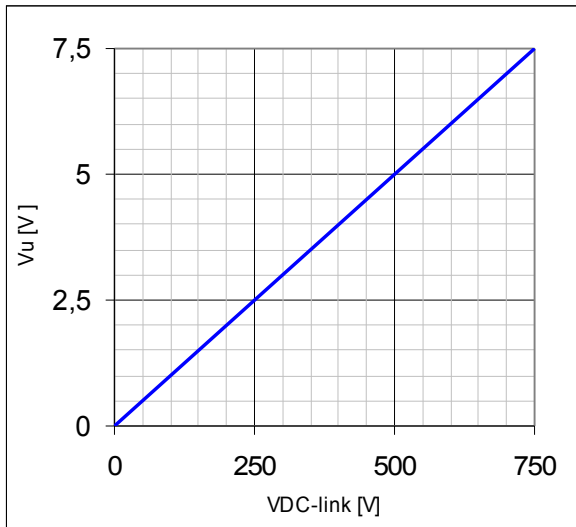

**note 3:**

$$R_T = R_{25} \cdot e^{B \left( \frac{1}{T[K]} - \frac{1}{298,15K} \right)}$$

## EXTERNAL CONNECTIONS

### Signal connections:

J1 CONTROL CONNECTOR (male DB-25) is the main connector for the control switching signals for each IGBT, reset signal, capacitor precharge relay signal, and output fault signals. Also can be used to supply the drivers +12 V<sub>DC</sub>. Pinout of this connector below.

Please find the device designation correspondence with the general schematic on the first page of this datasheet.

### J1 - DB25 CONTROL CONNECTOR

pin	designation	function
1	FAULT T1	Fault open collector output signal from T1 channel
2	RESET	Input logic signal for reset the driver
3	PWM T1	Input logic signal for switching T1 IGBT
4	GND CTL	Ground terminal for supply and logic signals ( <b>note 4</b> )
5	NC	Leave this pin unconnected
6	VIN	+12 V <sub>DC</sub> from supply voltage
7	FAULT T7	Fault open collector output signal from T7 channel
8	GND CTL	Ground terminal for supply and logic signals
9	PWM T7	Input logic signal for switching T7 IGBT
10	FAULT T6	Fault open collector output signal from T6 channel
11	GND CTL	Ground terminal for supply and logic signals
12	PWM T6	Input logic signal for switching T6 IGBT
13	RELAY	Input logic signal for switching the DC-Link relay ( <b>note 5</b> )
14	PWM T3	Input logic signal for switching T3 IGBT
15	VIN	+12 V <sub>DC</sub> from supply voltage
16	FAULT T3	Fault open collector output signal from T3 channel
17	PWM T5	Input logic signal for switching T5 IGBT
18	GND CTL	Ground terminal for supply and logic signals
19	FAULT T5	Fault open collector output signal from T5 channel
20	PWM T2	Input logic signal for switching T2 IGBT
21	VIN	+12 V <sub>DC</sub> from supply voltage
22	FAULT T2	Fault open collector output signal from T2 channel
23	PWM T4	Input logic signal for switching T4 IGBT
24	VIN	+12 V <sub>DC</sub> from supply voltage
25	FAULT T4	Fault open collector output signal from T4 channel

**Note 4:** All ground terminals "GND CTL" are internally interconnected.



**Note 5:** When powered, user must left "RELAY" signal to 0 V (relay open) to precharge the capacitor bank. The user must ensure the capacitor bank is completely charged before switching on the relay ("RELAY" = 1). This can be accomplished sensing the voltage on DC-Link or waiting for about 2 seconds.

J2 SENSORS CONNECTOR (female DB-25) is the main connector for the sensor signals: current outputs, DC-Link voltage and temperature sensor from CBI module. Below you can find the pinout for this connector.

## J2 - DB25 SENSORS CONNECTOR

pin	designation	function
1	DCLINK U	Leave this pin unconnected
2	DCLINK A	Output signal from DC-Link voltage sensor
3	OUT_I_U	Output signal from U line current sensor
4	OUT_I_V	Output signal from V line current sensor
5	OUT_I_W	Output signal from W line current sensor
6	NC	Leave this pin unconnected
7	NC	Leave this pin unconnected
8	NC	Leave this pin unconnected
9	NC	Leave this pin unconnected
10	NC	Leave this pin unconnected
11	NC	Leave this pin unconnected
12	NC	Leave this pin unconnected
13	NC	Leave this pin unconnected
14	VDD	15 V <sub>DC</sub> from supply voltage for sensors
15	VDD	15 V <sub>DC</sub> from supply voltage for sensors
16	VDD	15 V <sub>DC</sub> from supply voltage for sensors
17	GND SENS	Ground terminal for sensors supply and logic signals ( <b>note 6</b> )
18	GND SENS	Ground terminal for sensors supply and logic signals
19	NTC1	NTC1 signal from CBI module
20	NTC2	NTC2 signal from CBI module
21	GND SENS	Ground terminal for sensors supply and logic signals
22	GND SENS	Ground terminal for sensors supply and logic signals
23	VEE	-15 V <sub>DC</sub> from supply voltage for sensors
24	VEE	-15 V <sub>DC</sub> from supply voltage for sensors
25	VEE	-15 V <sub>DC</sub> from supply voltage for sensors

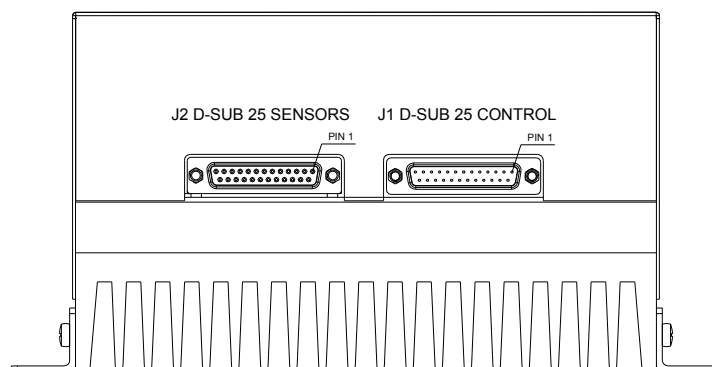

**Note 6:**

All ground terminals GND SENS are internally interconnected but isolated from GND\_CTL.

**Power connections:**

*J3 POWER TERMINALS* is the main power connector for the stack. There are the connections for the AC power supply (R, S, T). The output terminals (U,V, W) for the load, Brake and VDCLINK+ to use a brake resistor, earth connection and, additionally, connections for VDCLINK- and VDCLINK+R (positive output of DCLINK at the rectifier bridge output). Below you can find the pinout.

**J3 - POWER TERMINALS**

terminal	designation	function
1	EARTH	Earth connection
2	BRK	Brake output
3	NC	Leave this pole unconnected
4	VDCLINK +R	Positive power terminal from rectifier bridge
5	VDCLINK +I	Positive power terminal from inverter DC-Link
6	VDCLINK-	Negative power terminal from inverter DC-Link
7	R IN	R phase input
8	S IN	S phase input
9	T IN	T phase input
10	W OUT	W phase output
11	V OUT	V phase output
12	U OUT	U phase output

*J4 DC POWER SUPPLY CONNECTOR* is the auxiliary power connector for the stack. The system must be supplied with 12V<sub>DC</sub> with this connector. It supplies the power for the drivers, the precharge relay and the fans (if the system has a air forced heatsink).

**J4 - DC POWER SUPPLY CONNECTOR**

terminal	designation	function
1	VIN	12 V <sub>DC</sub> supply voltage
2	GND	GND supply voltage

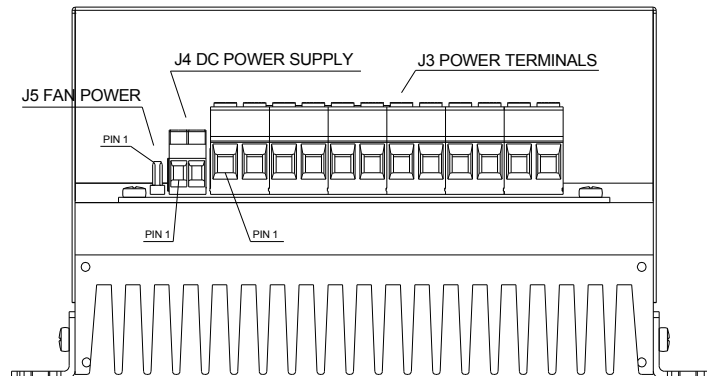

*J5 FAN POWER CONNECTOR* is the power connector for the fan system. This connector sinks directly the power from J4 connector. (Not used on natural cooling versions)

**J5 - FAN POWER CONNECTOR**

terminal	designation	function
1	GND	GND supply voltage
2	VIN	+12 V <sub>DC</sub> supply voltage



### POWER STACK SUPPLIES

<i>Description</i>	<i>symbol</i>	<i>notes/test conditions</i>	<i>min.</i>	<i>typ.</i>	<i>max.</i>	<i>units</i>
Driver voltage supply	$V_{IN}$		10.8	12	13.2	V
Driver power supply	$I_{IN}$		300		900	mA
Sensors voltage supply	$V_{SENSE}$			±15		V
Sensors power supply	$I_{SENSE}$		50		250	mA

In order to supply the power stack user must feed the drivers, capacitor bank precharge relay and fan system (if applicable) with 12  $V_{DC}$  from J3 or with the DB25 connector J2 (see: J2-DB25 CONTROL CONNECTOR pinout table).

Sensors must be supplied ( $\pm 15 V_{DC}$ ) through J1 (see : J1-DB25 SENSORS CONNECTOR pinout table).

**MECHANICAL DIMENSIONS** (All dimensions in mm.)

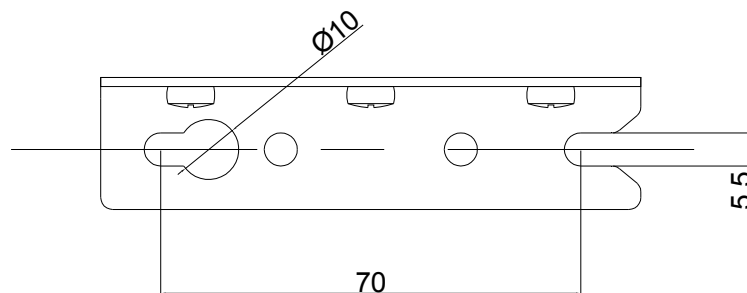
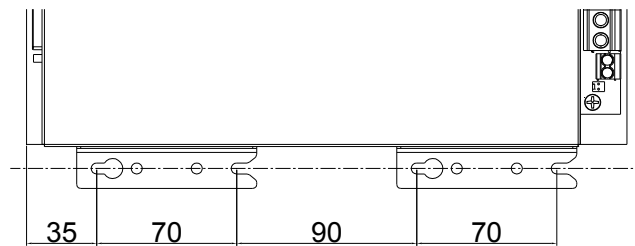
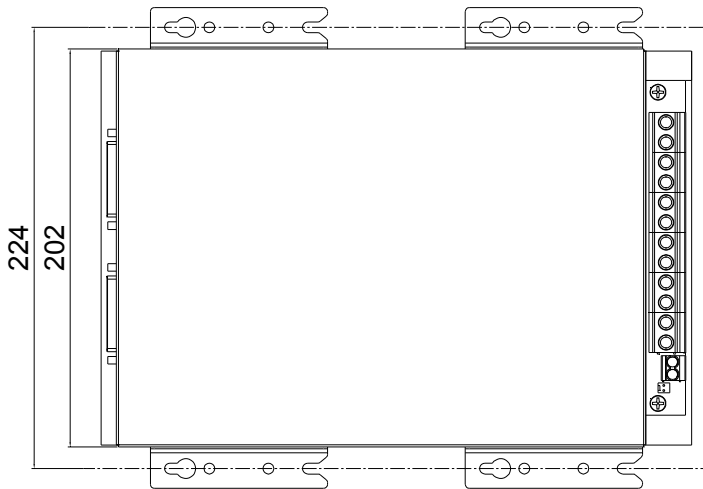
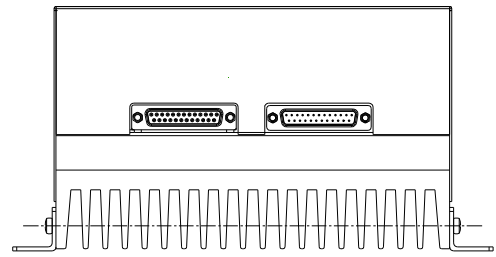
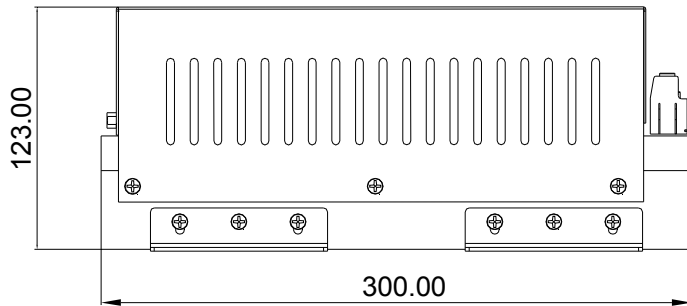

Reserves the right to change limits, test conditions and dimensions given in this data sheet at any time without previous notice.

**PERFORMANCE CURVES**

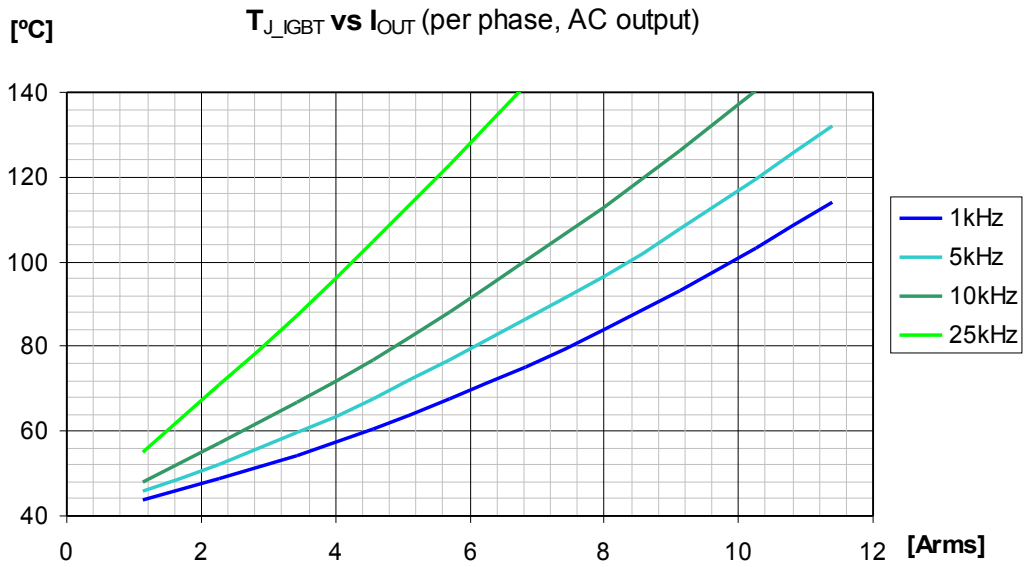

Condition	symbol	value	Units
Ambient temperature	T <sub>A</sub>	40	°C
Input voltage (each phase)	V <sub>IN</sub>	400	V <sub>RMS</sub>
Input frequency	f <sub>in</sub>	50	Hz
DC link voltage	V <sub>DClink</sub>	555	V <sub>DC</sub>
Modulation index	m	1	
Load power factor	PF	0,85	
Output frequency	f <sub>OUT</sub>	50	Hz

 **ANOTACIONES EN LA HOJA DE ESPECIFICACIONES:**

RECTIFICADORES GUASCH, S.A. utiliza la siguiente anotación para identificar el estado del producto, en el lado izquierdo de la primera página:

**PRELIMINARY TECHNICAL INFORMATION:** El producto se encuentra en proceso de diseño y desarrollo. La información presenta los datos del producto pero algunas características pueden cambiar.

**ADVANCED TECHNICAL INFORMATION:** El producto se encuentra totalmente diseñado y las características se refieren a la fabricación en serie.

*Sin anotación:* Los parámetros del producto están fijados y se suministra de acuerdo con las especificaciones publicadas.

Los datos indicados en esta publicación corresponden a especificaciones de producto, queda excluida cualquier garantía expresa o implícita sobre sus propiedades o su aplicación, así como cualquier responsabilidad sobre daños directos o indirectos producidos por los materiales o resultantes de su aplicación. La empresa se reserva el derecho de realizar cambios en las especificaciones de los productos sin previo aviso. La información respecto a métodos de uso y aplicaciones se indica sólo como guía y no constituye garantía alguna de funcionamiento satisfactorio en un determinado equipo o aplicación. Es responsabilidad del usuario determinar la idoneidad del producto para su aplicación utilizando la información disponible y asegurarse de que la misma esta actualizada.

Cualquier nombre de producto o marca usada en esta publicación corresponde a marcas depositadas, marcas registradas o nombres protegidos por sus respectivos propietarios.

 **DATASHEET ANNOTATIONS:**

RECTIFICADORES GUASCH, S.A. annotate datasheets in the left corner of the front page, to indicate product status:

**PRELIMINARY TECHNICAL INFORMATION:** The product is in design and development. The datasheet represents the product as it is understood but details may change.

**ADVANCED TECHNICAL INFORMATION:** The product design is complete and final characterisation for volume production is well in hand.

*No Annotation:* The product parameters are fixed and the product is available to datasheet specification.

The technical data are to specify components, not to guarantee their properties. No warranty or guarantee expressed or implied is made regarding delivery or performance. The Company reserves the right to alter without prior notice the specification of any product. Information concerning possible methods of use is provided as a guide only and does not constitute any guarantee that such methods of use will be satisfactory in a specific piece of equipment. It is the user's responsibility to fully determine the performance and suitability of any equipment using such information and to ensure that any publication or data used is up to date.

All brand names and product names used in this publication are trademarks, registered trademarks or trade names of their respective owners.

**© RECTIFICADORES GUASCH, S.A.**  
DOCUMENTACION TECNICA, TECHNICAL DOCUMENTATION  
PRODUCIDO EN ESPAÑA, PRODUCED IN SPAIN  
PROHIBIDA SU VENTA, NOT FOR SALE

**Your Needs, Our Solutions**