

Drawing Number – W18
Outline Number – 101A225

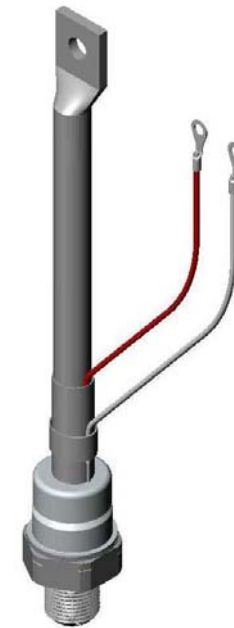
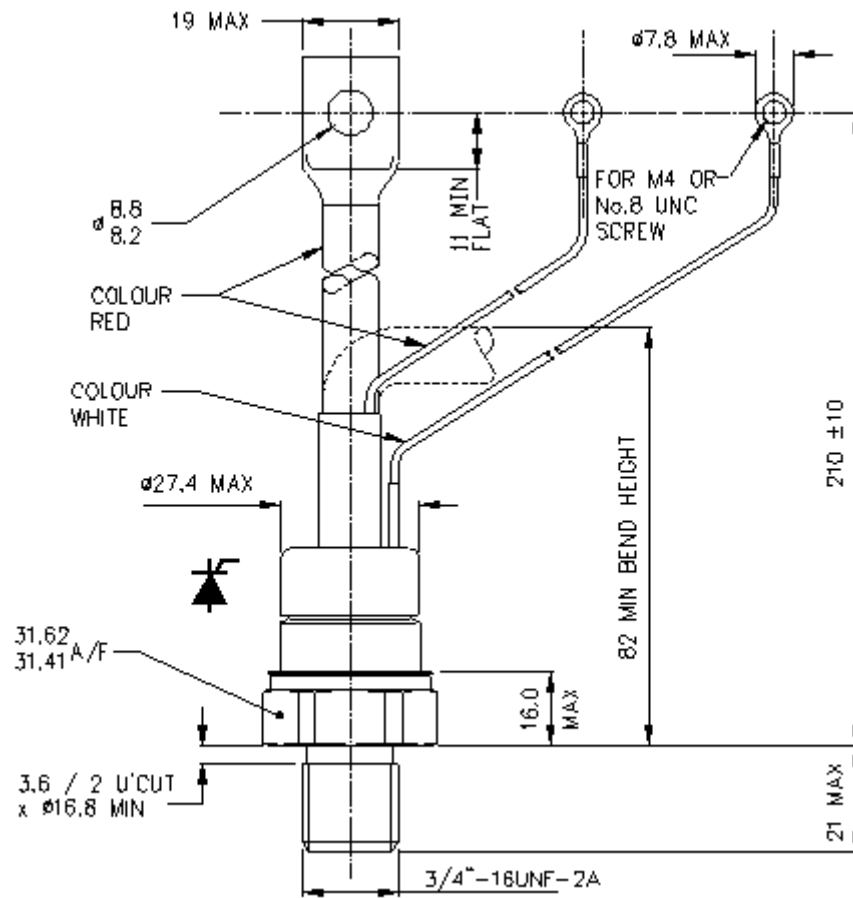

Weight 280g